



SUPPLIER AND DISTRIBUTOR OF

**PIPE, FLANGES, FITTINGS,
STRUCTURAL STEELS,
SCAFFOLDING, VALVES,
GASKET**



PT. GLOBAL BENUA BAJATAMA

ABOUT US

WHO WE ARE

PT Global Benua Bajatama founded in 2019 is a company engaged in providing various types of pipes and fittings to shipyards, oil and gas companies, and other industries. We are determined to provide quality and competitive products.

With persistence and consistent management in optimizing the supply chain from suppliers, as well as maintaining good relationships with stakeholders we aim to achieve our goal in providing quality products.



OUR VISION & MISSION

“To excel as the leading supplier in our industry, renowned for delivering unmatched value through the highest quality products, exceptional service, and proactive problem resolution.”

“Committed to affordability, ensuring competitive prices, consistent product availability, and unwavering quality assurance, all while fostering enduring customer relationships.”



JALAN KERAPU NO. 88 BATU AMPAR-BATAM



WHY CHOOSE US?

Competitive

We are committed to offering competitive pricing through the strategic utilization of manufacturing facilities that consistently produce high-quality goods with efficiency and effectiveness

Commitment

We are steadfastly dedicated to delivering excellence in service, whether prior to or following your engagement with us. Your valuable feedback and constructive criticism play an integral role in our continuous efforts to enhance the quality of our service

Product Quality

We are resolutely committed to delivering products with certificates and specifications that precisely align with the requirements of our esteemed partners

Availability of Goods

We are resolute in our commitment to consistently deliver products punctually, in strict adherence to our commitments to our partners, thereby mitigating unnecessary costs

OUR PRODUCTS

- Pipe
- Flanges
- Fittings
- Structural Steels
- Scaffolding
- Valves
- Gasket

STEEL PROFILES

MATERIAL

MILD STEEL, CARBON STEEL, STAINLESS STEEL, GALVANISED

THICKNESS

1MM-100MM



H-Beam



Chequered Plate



Marine Plate

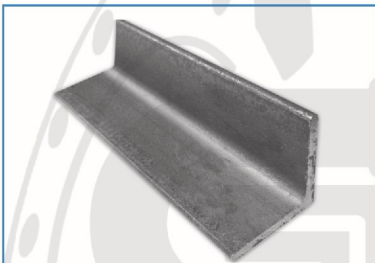

Angle Bar



Round Bar



Flat Bar



Square Bar

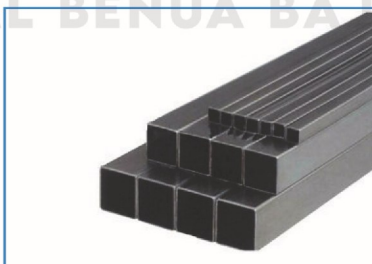

Hollow Bar



Channel Bar

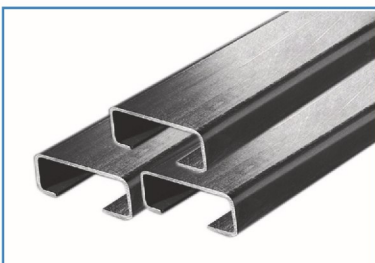

Lip Channel



Grating

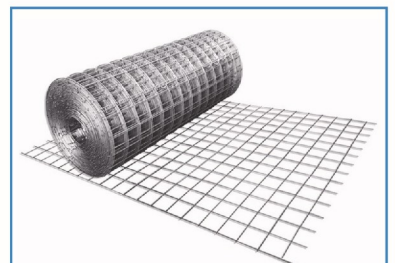

Wiremesh

MATERIAL

MILD STEEL, CARBON STEEL, STAINLESS STEEL, GALVANISED

THICKNESS

STD, XS, XXS, S20, S40, S80, S120, S160

SIZE

1/2"-50"



MATERIAL	MILD STEEL, CARBON STEEL, STAINLESS STEEL, GALVANISED	
THICKNESS	*JIS STANDARD	5K, 10K, 16K, 20K, 40K
	*DIN STANDARD	PN6, PN10, PN16, PN25, PN40
	*ANSI STANDARD	150#, 300#, 600#, 900#, 1500#, 2500#
SIZE	1/2"-50"	

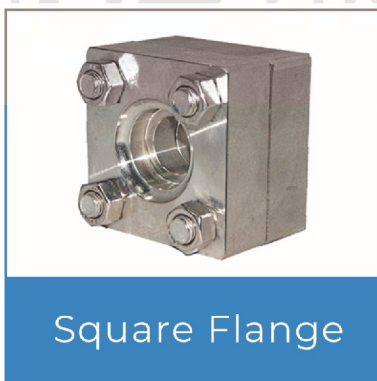

MATERIAL	MILD STEEL, CARBON STEEL, STAINLESS STEEL, GALVANISED
THICKNESS	STD, XS, XXS, S20, S40, S80, S120, S160
SIZE	1/4"-50"

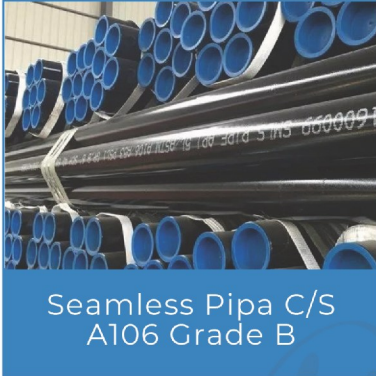

MATERIAL

MILD STEEL, CARBON STEEL, STAINLESS STEEL, GALVANISED

PRESSURE

150#, 3000#, 6000#



Elbow Drat Dalam



Tee Drat Dalam



Nipple Drat Dalam



Union



Elbow Drat Luar



Double Nipple



Dop



Plug



Elbow Forged



Tee Forged



Coupling



Brass Camlock

FITTINGS

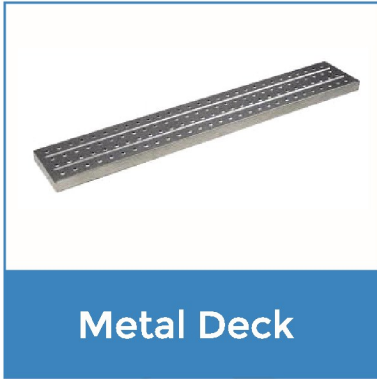

Metal Deck



Scaffolding Pipe



Fixed / Swivel Clamp



Fixed / Swivel Beam Clamp



Bore Joint



Joint Pin



Roda Scaffolding



Sleeve Coupler



Monkey Ladder



Ladder Scaffolding



U Head Jack

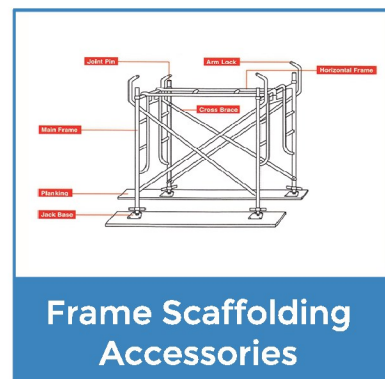

Frame Scaffolding Accessories

SCAFFOLDING

MATERIAL

CAST IRON, CAST STEEL, BRONZE

PRESSURE

JIS STANDARD 5K, 10K, 16K, 20K, 40K

*DIN STANDARD PN6, PN10, PN16, PN25, PN40

*ANSI STANDARD 150#, 300#, 600#, 900#, 1500#, 2500#



Gate Valve



Globe Valve



Angle Valve



SDNR Globe Valve



SDNR Angle Valve



Swing Check Valve



Y-Type Strainer



Air Vent Head



53ON Air Vent Head



Can Water Filter



Simplex Oil Strainer



Marine Mud Box L-Type



Deck Stand Valve



Self Closing Drain Valve



Emergency Shut-Off Valve



Globe Storm Valve



Angle Storm Valve



Gear Handle Butterfly Valve



Lever Handle Wafer Butterfly Valve



Lever Handle Lug Butterfly Valve



Gear Handle Lug Butterfly Valve



Self Closing Gate Valve



Class 150 Gate Valve

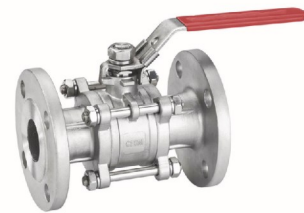

Flange Ball Valve



Rose Box



Semi Rotary Hand Pump



Nakajima Type Hydrant Valve

VALVES

